

# Installation



## LineLazer IV Second Gun Kit 287553

311066C  
ENG

*3300 psi (22.8 MPa, 228 bar) Maximum Working Pressure*

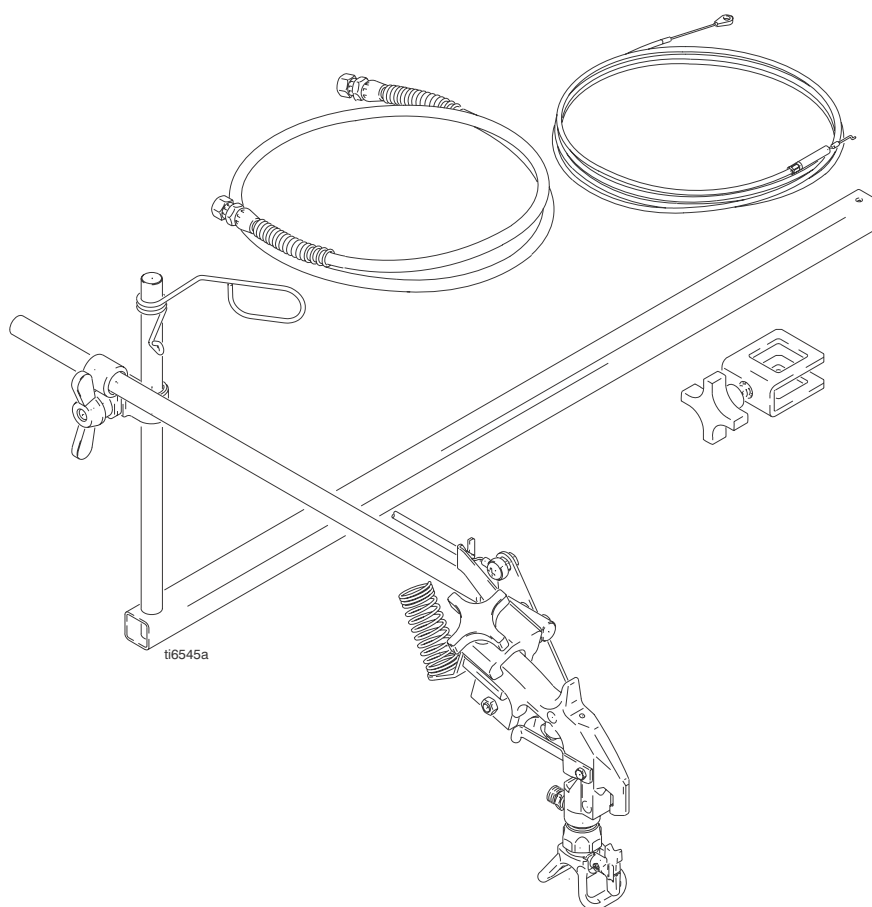

### **Important Safety Instructions**

Read all instructions and warnings in manuals 311020, 311021, or 313775. Save these instructions.

PROVEN QUALITY. LEADING TECHNOLOGY.



H003

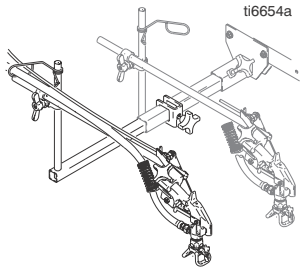
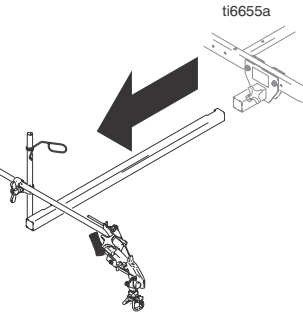
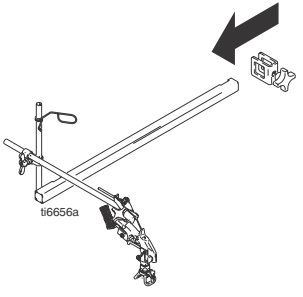
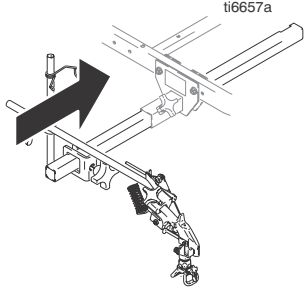
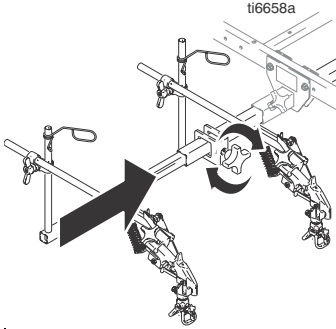
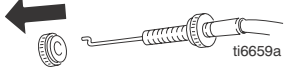
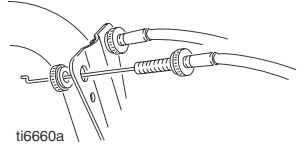
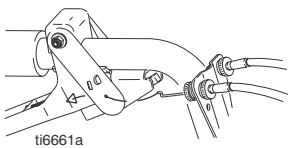
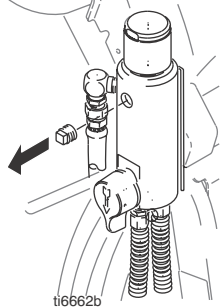
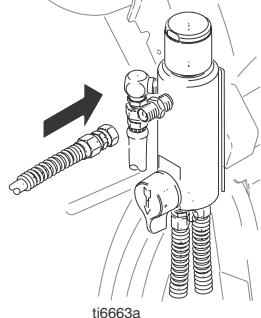
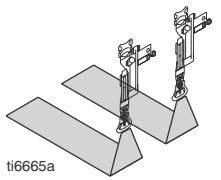

			
<p>Relieve pressure. Refer to your sprayer manual.</p>	<p>1 Install extension clamp (10) and extension support bracket (12)</p>	<p>a Pull out existing gun arm support bracket</p>	<p>b Slide extension clamp onto existing gun arm support bracket</p>
			
<p>c Install existing gun support bracket.</p>	<p>2 Install extension support bracket (12). Tighten extension clamp (10).</p>	<p>3 Route gun cable (1) up to cable bracket on handle bar. Remove knurled nut near end of gun cable.</p>	<p>4 Insert gun cable through cable bracket. Install and tighten knurled nut.</p>
			
<p>5 Insert gun cable in gun selector plate</p>	<p>6 Remove plug from filter.</p>	<p>7 Connect paint hose to filter.</p>	<p>8 Adjust cable and gun trigger so both guns trigger at the same time.</p>

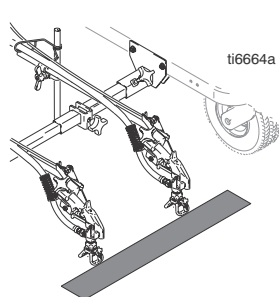
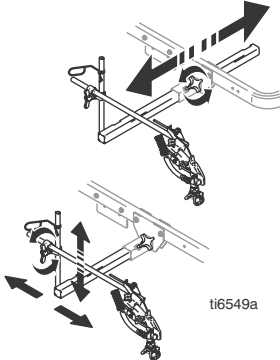
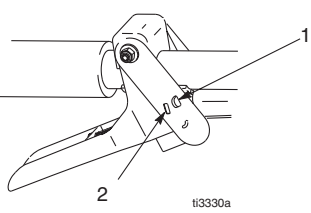
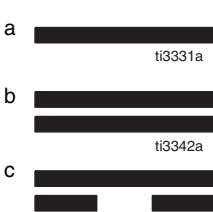
 <p>ti6664a</p>	 <p>ti6549a</p>	 <p>ti3330a</p>	 <p>a ti3331a</p> <p>b ti3342a</p> <p>c</p>
<p>1 Align guns</p>	<p>2 Position guns: up/down, forward/reverse, left right</p>	<p>3 Connect gun cables to left or right, or both, selector plates</p>	<p>a One gun: Disconnect one gun selector plate from trigger.</p> <p>b Both guns simultaneously: Adjust both gun selector plates to the same position.</p> <p>c Solid-skip and skip-solid: Adjust solid-line gun to position 1 and skip-line gun to position 2.</p>

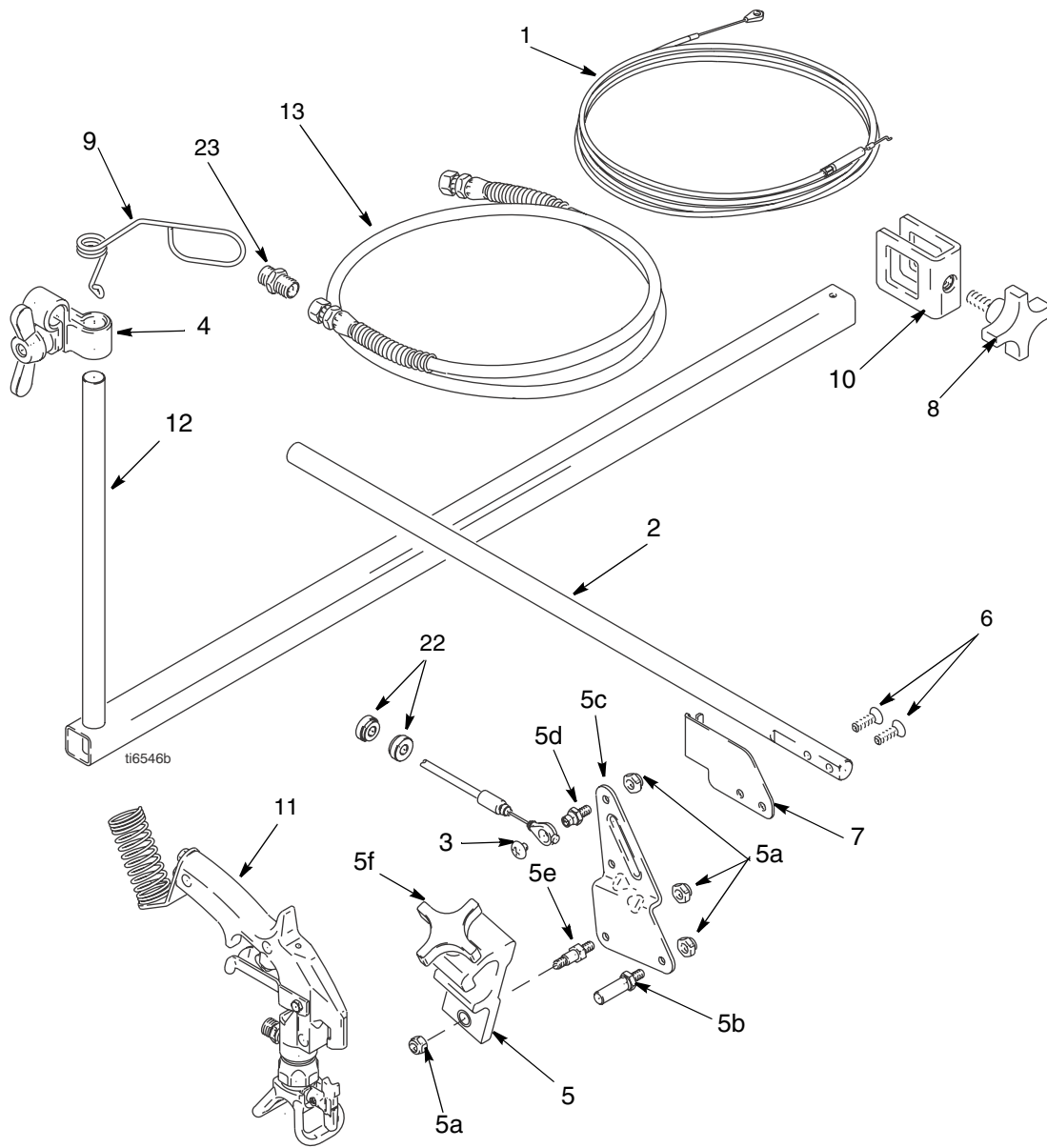

Ref	Part	Description	Qty	Ref	Part	Description	Qty
1	287696	CABLE, gun	1	8	111145	KNOB, pronged	1
2	15F212	ARM, holder, gun	1	9	188135	GUIDE, cable	1
3	119648	SCREW, mch, trsshd, cross recess	1	10	224136	CLAMP, extension	1
4	287566	KIT, clamp	1	11	248157	GUN, flex, basic	1
5	287570	HOLDER, gun; includes 5a - 5f	1	12	224096	BRACKET, support, extension	1
5a	102040	NUT, lock	4	13	245798	HOSE, 1/4 in. X 7 ft	1
5b	15F209	STUD, trigger pull	1	22	15F624	NUT, cable, gun (knurled)	2
5c	15F214	LEVER, actuator	1	23	196177	FITTING, adaptor	1
5d	15F211	STUD, cable	1				
5e	15F210	STUD, pivot	1				
5f	287569	HOLDER, GUN	1				
6	119647	SCREW, cap, socket, flthd	2				
7	15F213	BRACKET, cable	1				

## Ordering Information



For the latest information about Graco products, visit [www.graco.com](http://www.graco.com).

**TO PLACE AN ORDER, contact Graco® ProStore by RAE Products at 1-877-275-7550 or visit [www.RaeProStores.com](http://www.RaeProStores.com)**

For the latest information about Graco products, visit [www.graco.com](http://www.graco.com).

All written and visual data contained in this document reflects the latest product information available at the time of publication. Graco reserves the right to make changes at any time without notice.

Original instructions. This manual contains English. MM 311066

**Graco Headquarters:** Minneapolis  
**International Offices:** Belgium, Korea, China, Japan

**GRACO INC. P.O. BOX 1441 MINNEAPOLIS, MN 55440-1441**

**Copyright 2005, Graco Inc. is registered to ISO 9001**  
<http://www.graco.com>